



DFS MEASUREMENT REPORT

EN 302 502 V1.2.1

Applicant: Compex Systems Pte Ltd

Address: No:9 Harrison Road, Harrison Industrial Building, #05-01,
Singapore 369651

Product: 802.11ac Dual Band Module

Model No.: WLE600VX, WLE600VX-I

Brand Name: COMPEX

Standards: EN 302 502 V1.2.1 (2007-08) Clause 4.6

Type of Device: Master Device
 Client Device without radar detection
 Client Device with radar detection

Result: Complies

Test Date: Mar. 16 ~ Jun. 15, 2015

Reviewed By : Robin Wu
(Robin Wu)

Approved By : Marlin Chen
(Marlin Chen)



The test results relate only to the samples tested.
The test results shown in the test report are traceable to the national/international standards through the calibration of the equipment and evaluated measurement uncertainty herein.
The test report shall not be reproduced except in full without the written approval of MRT Technology (Suzhou) Co., Ltd.

Revision History

Report No.	Version	Description	Issue Date
1612RSU02406	Rev. 01	Initial report	07-11-2017

Note: This report was based on the original report no. 1503RSU02909 and add one type antenna 7#.

CONTENTS

Description	Page
1. General Information	5
1.1. Applicant.....	5
1.2. Manufacturer	5
1.3. Testing Facility	5
1.4. Feature of Product	6
1.5. Product Specification Subjective to this Report.....	6
1.6. Operation Frequency / Channel List	6
1.7. Description of Available Antennas.....	7
1.8. Test Channel / Test Mode	7
1.9. Standards Applicable for Testing.....	7
2. DFS Requirements and Radar Test Waveforms	8
2.1. Applicability	8
2.2. DFS Detection Threshold Values	8
2.3. Radar Wave Parameters	8
2.4. Conducted Test Setup	11
3. Test Equipment Calibration Date	12
4. Test Summary.....	13
5. Test Result.....	14
5.1. Radar Waveform Calibration.....	14
5.2. Initial Channel Availability Check Time Measurement	19
5.2.1 Test Limit	19
5.2.2 Test Procedure	19
5.2.3 Test Result.....	19
5.3. Radar Burst at the Beginning of the Channel Availability Check Time Measurement ..	20
5.3.1 Test Limit	20
5.3.2 Test Procedure	20
5.3.3 Test Result.....	21
5.4. Radar Burst at the End of the Channel Availability Check Time Measurement.....	22
5.4.1 Test Limit	22
5.4.2 Test Procedure	22
5.4.3 Test Result.....	23
5.5. Interference Detection Threshold (during the Channel Availability Check)	24
5.5.1 Test Limit	24
5.5.2 Test Procedure	24
5.5.3 Test Result.....	25
5.6. In-Service Monitoring Measurement	26

5.6.1 Test Limit	26
5.6.2 Test Procedure Used	26
5.6.3 Test Result.....	27
5.7. Channel Shutdown and Non-Occupancy Period	28
5.7.1 Test Limit	28
5.7.2 Test Procedure Used	28
5.7.3 Test Result.....	29

1. General Information

1.1. Applicant

Compex Systems Pte Ltd

No:9 Harrison Road, Harrison Industrial Building, #05-01, Singapore 369651

1.2. Manufacturer

Compex Systems Pte Ltd

No:9 Harrison Road, Harrison Industrial Building, #05-01, Singapore 369651

1.3. Testing Facility

Test Site

MRT Technology (Suzhou) Co., Ltd

Test Site Location

D8 Building, No.2 Tian'edang Rd., Wuzhong Economic Development Zone, Suzhou, China

Test Facility / Accreditations

Measurements were performed at MRT Laboratory located in Tian'edang Rd., Suzhou, China

- MRT facility is a FCC registered (MRT Reg. No. 809388) test facility with the site description report on file and has met all the requirements specified in Section 2.948 of the FCC Rules.
- MRT facility is an IC registered (MRT Reg. No. 11384A-1) test laboratory with the site description on file at Industry Canada.
- MRT facility is a VCCI registered (R-4179, G-814, C-4664, T-2206) test laboratory with the site description on file at VCCI Council.
- MRT Lab is accredited to ISO 17025 by the American Association for Laboratory Accreditation (A2LA) under the American Association for Laboratory Accreditation Program (A2LA Cert. No. 3628.01) in EMC, Telecommunications and Radio testing for FCC, Industry Canada, EU and TELEC Rules.



1.4. Feature of Product

Product Name	802.11ac Dual Band Module
Model No.	WLE600VX, WLE600VX-I
Brand Name	COMPEX
Wi-Fi Specification	802.11a/b/g/n/ac

1.5. Product Specification Subjective to this Report

Frequency Range	802.11a/n-HT20/ac-VHT20: 5745 ~ 5825MHz
Channel Number	802.11a/n-HT20/ac-VHT20: 5
Type of Modulation	802.11a/n/ac: OFDM
Data Rate	802.11a: 6/9/12/18/24/36/48/54Mbps 802.11n: up to 300Mbps 802.11ac: up to 866.6Mbps

Note: For other features of this EUT, test report will be issued separately.

1.6. Operation Frequency / Channel List

802.11a/n-HT20/ac-VHT20

Channel	Frequency	Channel	Frequency	Channel	Frequency
149	5745 MHz	153	5765 MHz	157	5785 MHz
161	5805 MHz	165	5825 MHz	N/A	N/A

1.7. Description of Available Antennas

Antenna No.	Manufacturer	Tx Paths	Max Directional Gain (dBi)
Antenna 1#	Kunshan Wavelink Electronic Co., Ltd.	2	2.4GHz: 2.0, 5GHz: 2.0
Antenna 2#	TAOGLAS Inc	2	2.4GHz: 4.5, 5GHz: 6.7
Antenna 3#	Compex Systems Pte Ltd	2	2.4GHz: 5.0, 5GHz: 5.0
Antenna 4#	Compex Systems Pte Ltd	2	2.4GHz: 5.0, 5GHz: 5.0
Antenna 5#	Smart Ant Inc	2	5GHz: 7.0
Antenna 6#	Kenbotong Communication LTD	2	5GHz: 10.0
Antenna 7#	Sensor Systems, Inc.	2	2.4GHz 5.0, 5GHz: 8.0

Note 1: The frequency bands (5150~5350MHz & 5470~5725MHz) support the max antenna gain 7dBi and another frequency band (5725~5850MHz) supports the max antenna gain 10dBi.

Note 2: We selected the antenna 5# for all radiated emission testing.

1.8. Test Channel / Test Mode

Test Mode	Test Channel	
802.11n-HT20	149	5745MHz

1.9. Standards Applicable for Testing

The EUT complies with the requirements of EN 302502 V1.2.1 clause 4.6.

2. DFS Requirements and Radar Test Waveforms

2.1. Applicability

Table 2-1: DFS requirement values

Parameter	Value
Channel Availability Check Time	60 s
Channel Move Time	10 s
Channel Closing Transmission Time	260 ms
Non-Occupancy Period	30 min
Channel Revalidation Period	24 hours

2.2. DFS Detection Threshold Values

Table D 2-2: Interference threshold values

EIRP Spectral Density dBm/MHz	Value (see notes 1 and 2)
23	-69 dBm
NOTE 1: This is the level at the input of the receiver assuming a 0 dBi receive antenna. NOTE 2: For FWA devices employing lower EIRP spectral density and a receive antenna gain G (dBi) the threshold follows the following relationships. DFS Detection Threshold (dBm) = -69 + 23 -EIRP Spectral Density (dBm/MHz) + G (dBi). See table D.4 for example calculations.	

2.3. Radar Wave Parameters

Table 2-3: DFS Test Signals simulating fixed frequency radars

Radar test signal (see notes 2)	Pulse width W [μs](see note 5) Choose one value	Pulse repetition frequency PRF (PPS) Choose one value	Pulses per burst (see notes 1 and 3)	Detection probability with 30% channel load (see note 4)
1-Fixed	1	750	15	Pd > 60 %
2-Variable	1,2,5	200,300,500,800,1000	10	Pd > 60 %
3-Variable	10,15	200,300,500,800,1000	15	Pd > 60 %
4-Variable	1,2,5,10,15	1200,1500,1600	15	Pd > 60 %
5-Variable	1,2,5,10,15	2300,3000,3500,4000	25	Pd > 60 %
6-Variable modulated (see note 6)	20,30	2000,3000,4000	20	Pd > 60 %
NOTE 1: This represents the number of pulses seen at the device per radar scan:				

$N = \{ \text{antenna beamwidth (deg)} \} \times \{ \text{pulse repetition rate (pps)} \} / \{ \text{scan rate (deg/s)} \}$.

NOTE 2: The test signals above only contain a single burst of pulses. See figure 2-1.

NOTE 3: The number of pulses per burst given in this table simulate real radar systems and take into account the effects of pulse repetition rate and pulse width on the detection probability for a single burst.

NOTE 4: Pd gives the probability of detection per simulated radar burst and represents a minimum level of detection performance under defined conditions - see clause 5.1.2.2.

Therefore Pd does not represent the overall detection probability for any particular radar under real life conditions. In general 5 sequential bursts are needed to achieve a real life detection rate of better than 99 % for any radar that falls within the scope of the above table.

NOTE 5: The pulse width used in these tests is assumed to be representative of real radar systems with different pulse widths and different modulations. The pulse width is assumed to have an accuracy of $\pm 5\%$.

NOTE 6: The modulation to be used for the radar test signal 6 is a chirp modulation with a $\pm 2,5$ MHz frequency deviation which is illustrated below.

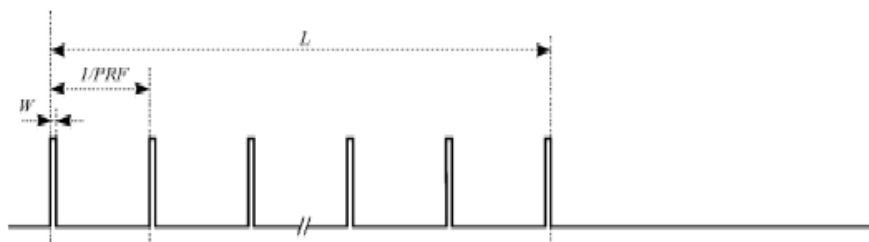
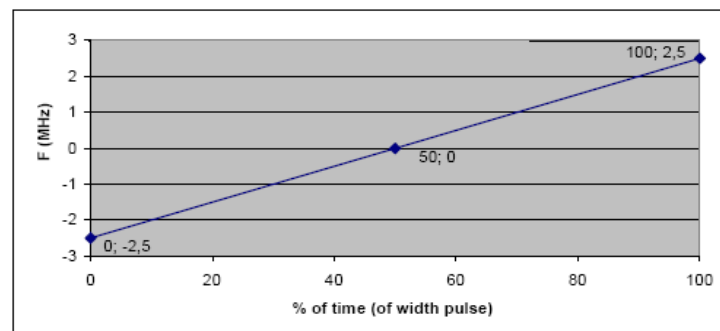

Figure 1: General structure of a single burst DFS test transmission

Table 2-4: DFS Test Signals simulating Frequency Hopping radars

Radar test signal	Pulse width W[μs]	Pulse repetition Frequency PRF [pps]	Pulses Per burst	Burst Length [ms]	Bursts per Trial (see note 4)	Pulse modulation (see note 1)	Detection Probability Pd with 30 % channel load (see note 2)
1	1	3000	9	3	8	none	see note 3
2	20	4500	9	2	2	chirp	see note 3

NOTE 1: Modulation used is defined in note 6, Table 2-3.

NOTE 2: Pd gives the probability of detection per simulated radar test signal and represents a minimum level of detection performance under defined conditions - see clause 5.1.2.2.

The test is performed using a minimum of 30 trials per test signal. The probability of detection is calculated by

$$Pd = \frac{\text{TotalSetDetections}}{\text{TotalSetTrials}} \times 100.$$

NOTE 3: For ChS = 10 MHz, Pd > 60 %; for ChS = 20 MHz, Pd > 70 %.

NOTE 4: For each of the trials, the burst interval will increase from 1,25 ms to 37,5 ms in Steps of 1,25 ms for radar signal 1 and from 5 ms to 150 ms in Steps of 5 ms for radar signal 2.

Table 2-5: Example Interference Threshold values

Maximum EIRP (dBm)	Channel Width (MHz) ChS	EIRP Spectral Density (dBm/MHz)	Interference Threshold (dBm)	Antenna Gain (dBi)	DFS Detection Threshold (dBm)
29.87	20	20.18	-69	10	-56.18

Note: We use the worst interference threshold -69dBm for DFS testing.

2.4. Conducted Test Setup

The following equipment setup was used to calibrate the conducted radar waveform. A spectrum analyzer was used to establish the test signal level for each radar type. During this process there were no transmissions by either the master or client device. The spectrum analyzer was switched to the zero spans (time domain) at the frequency of the radar waveform generator. Peak detection was utilized. The spectrum analyzer resolution bandwidth (RBW) and video bandwidth (VBW) were set to 1 MHz and 3 MHz.

The signal generator amplitude was set so that the power level measured at the spectrum analyzer was -55dBm due to the interference threshold level is not required

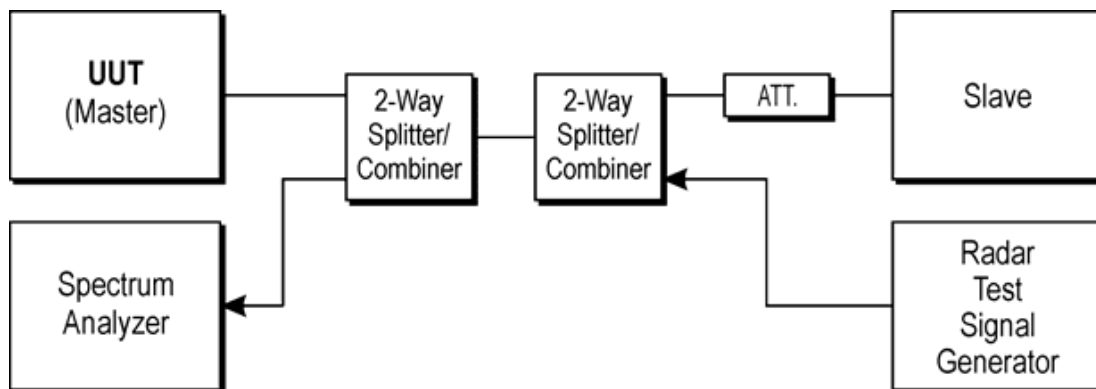

DFS Test Set-up Photo for Master Device - Set-up A

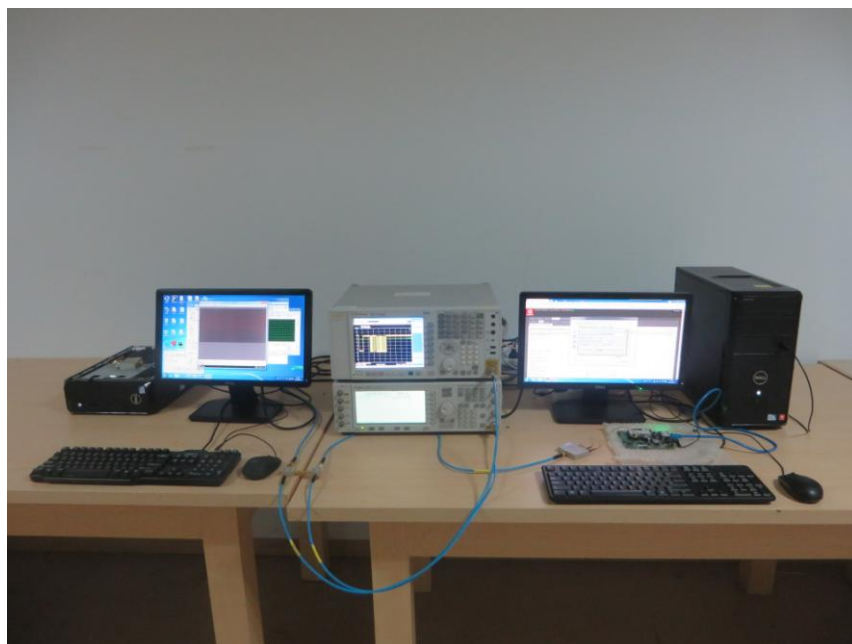

3. Test Equipment Calibration Date

Dynamic Frequency Selection (DFS)

Instrument	Manufacturer	Type No.	Cali. Interval	Cali. Due Date
Spectrum Analyzer	Agilent	N9020A	1 year	2016/04/23
ESG Vector Signal Generator	Agilent	E4438C	1 year	2015/12/09

Software	Manufacturer	Function
Pulse Building	Agilent	Radar Signal Generation Software
DFS Tool	Agilent	DFS Test Software

4. Test Summary

Parameter	Limit	Test Result	Reference
Radar Waveform Calibration	Refer Table 2-3 and 2-4	Pass	Section 5.1
Initial Channel Availability Check Time	Refer Table 2-1	Pass	Section 5.2
Radar Burst at the Beginning of the Channel Availability Check Time	Refer Table 2-1	Pass	Section 5.3
Radar Burst at the End of the Channel Availability Check Time	Refer Table 2-1	Pass	Section 5.4
Interference Detection Threshold	Refer Table 2-2	Pass	Section 5.5
In-Service Monitoring	Refer Table 2-1	Pass	Section 5.6
Channel Move Time, Channel Closing Transmission Time and Non-Occupancy Period	Refer Table 2-1	Pass	Section 5.7

5. Test Result

5.1. Radar Waveform Calibration

The following equipment setup was used to calibrate the conducted radar waveform. A spectrum analyzer was used to establish the test signal level for each radar type. During this process there were no transmissions by either the master or client device. The spectrum analyzer was switched to the zero spans (time domain) at the frequency of the radar waveform generator. Peak detection was utilized. The spectrum analyzer resolution bandwidth (RBW) and video bandwidth (VBW) were set to 1 MHz and 3 MHz.

Conducted Calibration Setup

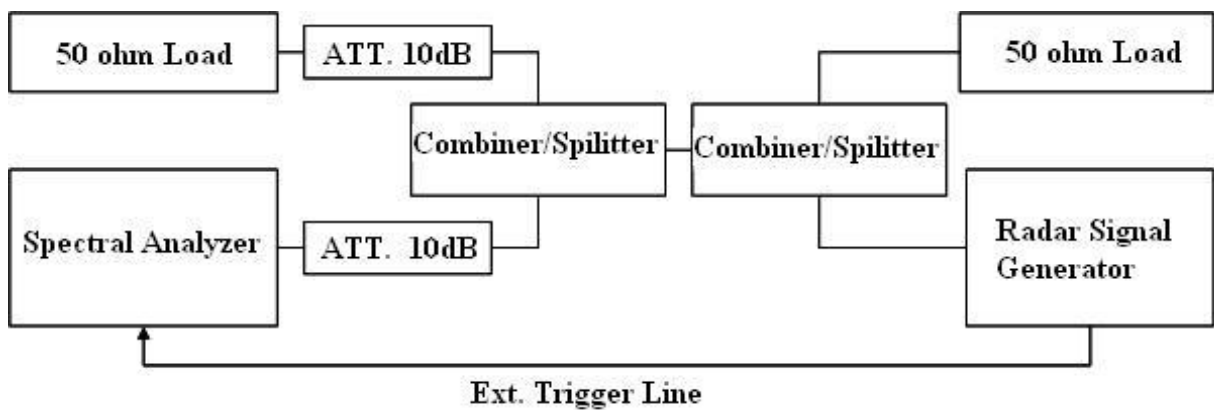

Radars Type 1 Calibration Plot

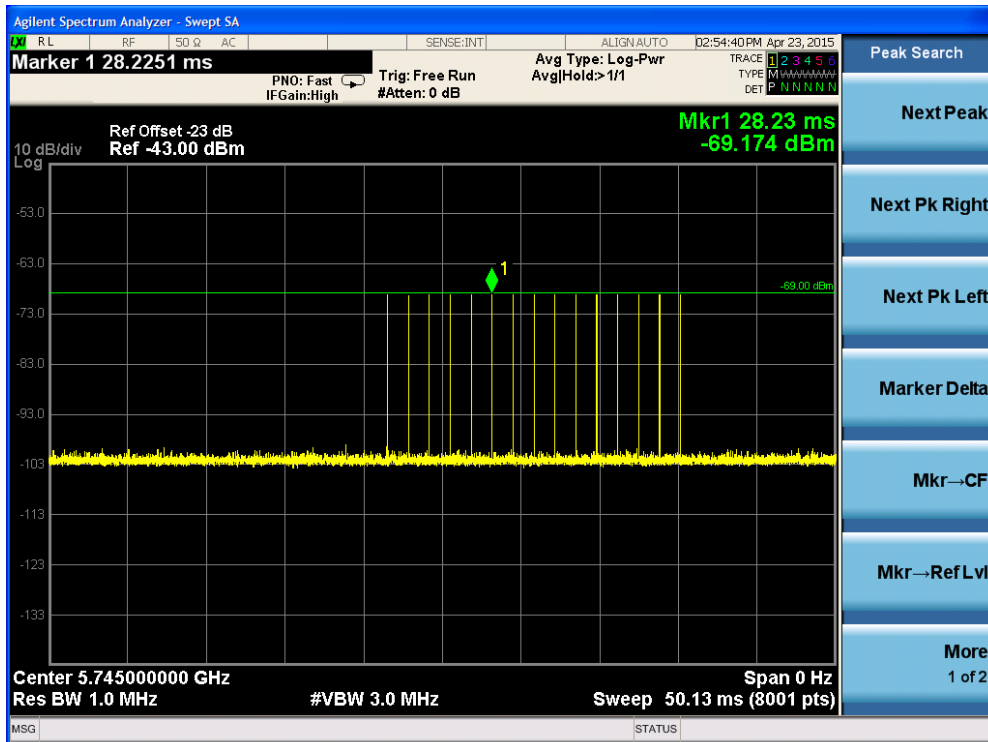

Radars Type 2 Calibration Plot

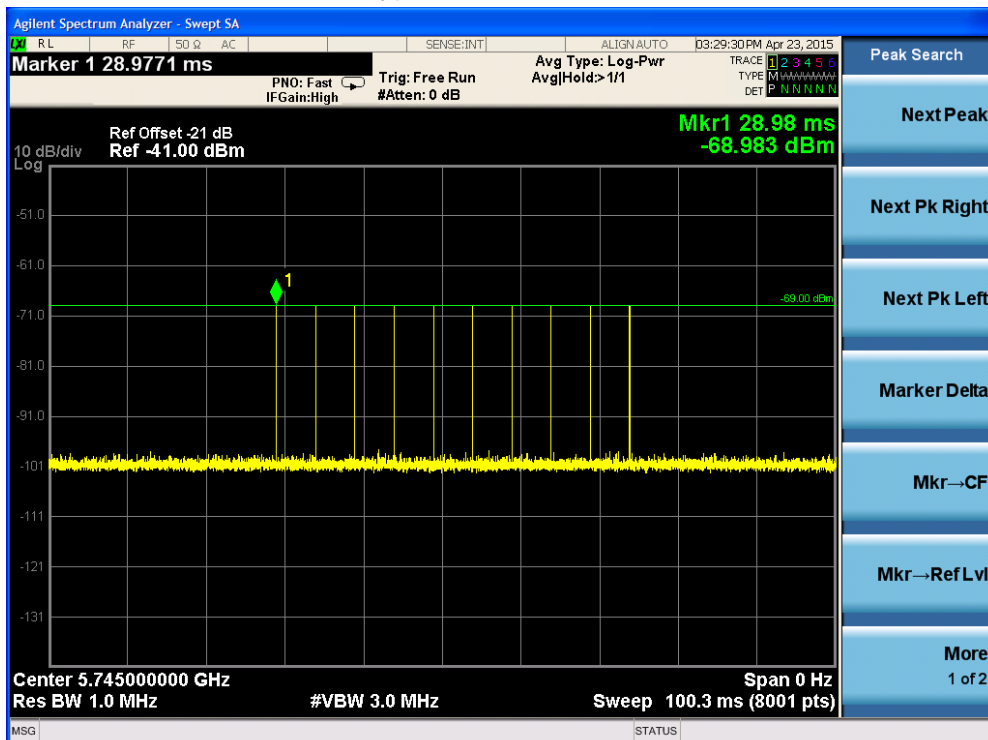

Radar Type 3 Calibration Plot

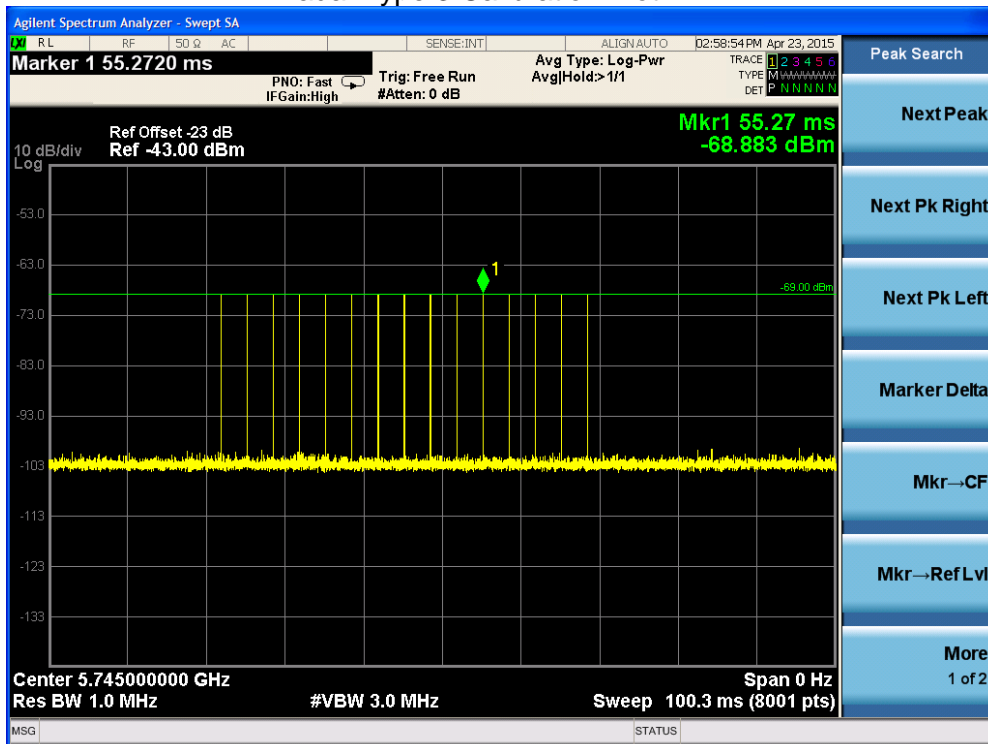

Radar Type 4 Calibration Plot

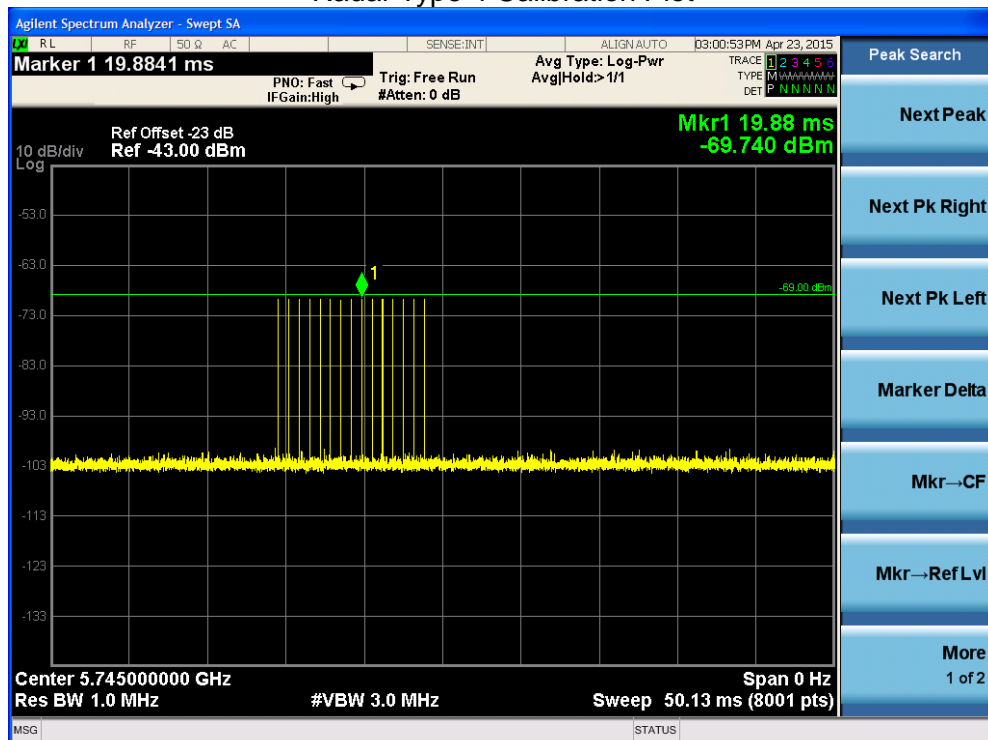

Radars Type 5 Calibration Plot

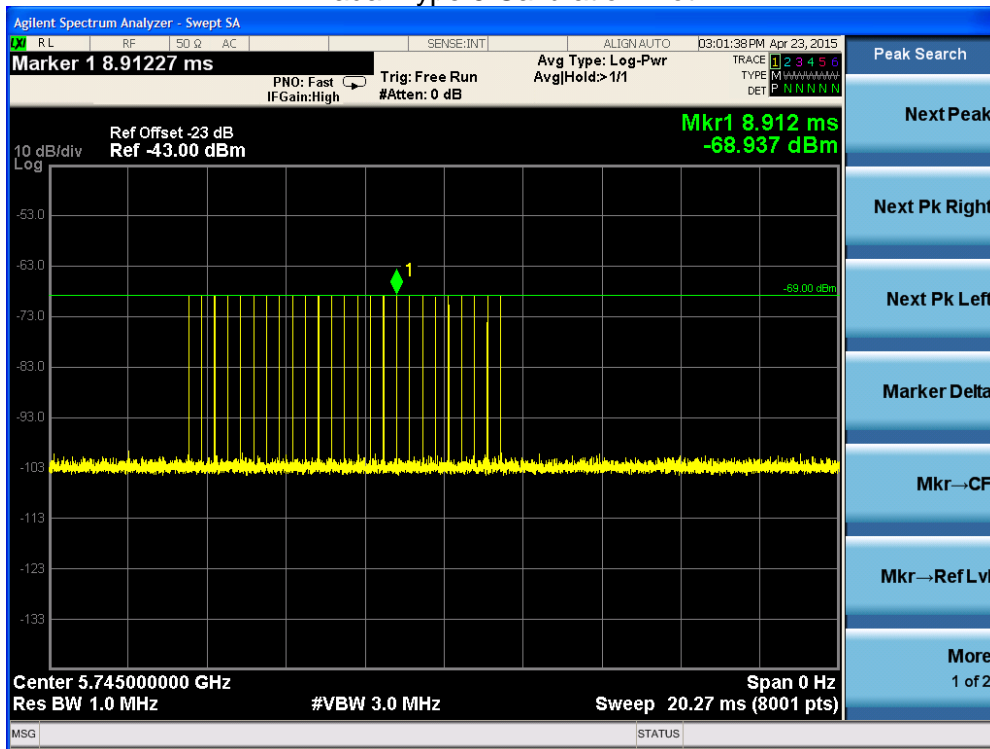

Radars Type 6 Calibration Plot

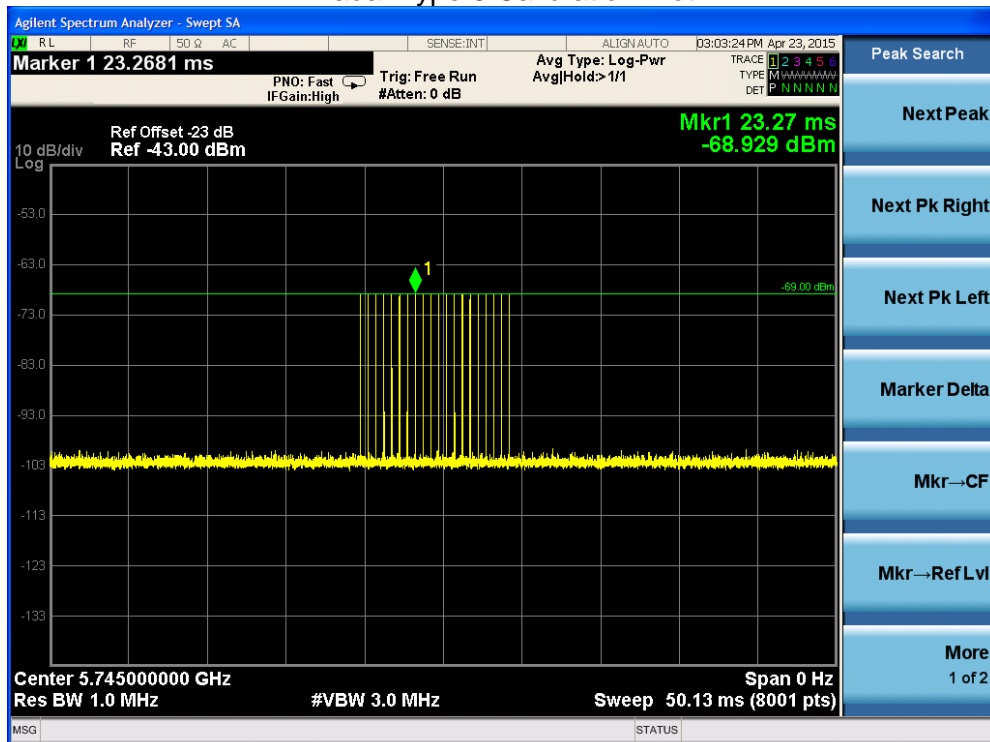

Hopping Radar Type 1 Calibration Plot

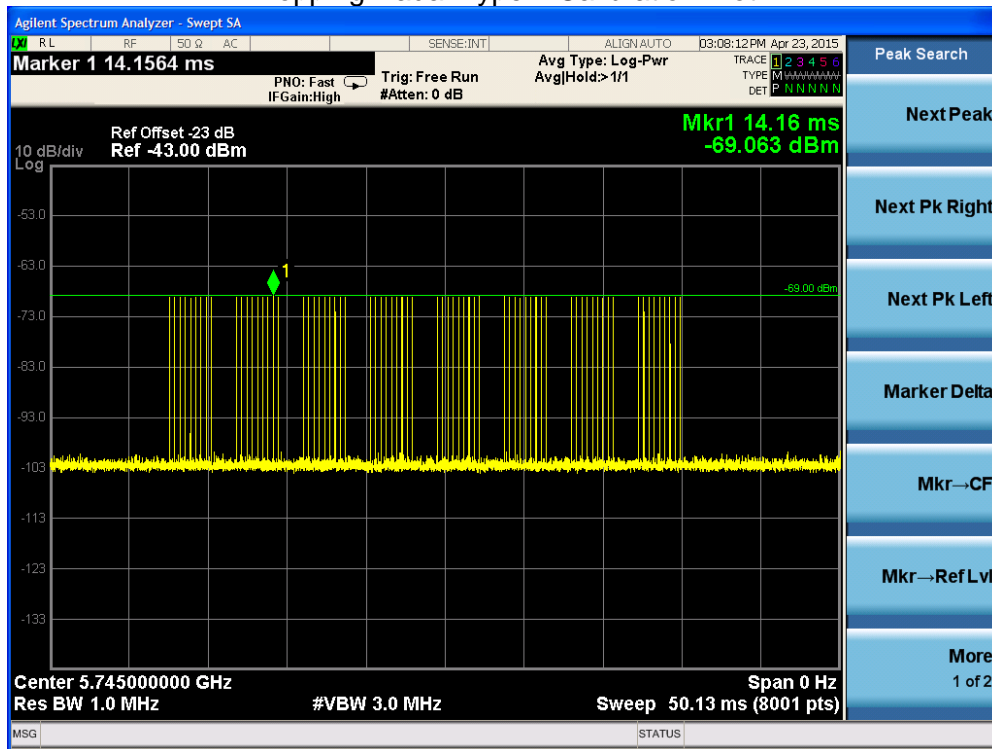

Hopping Radar Type 2 Calibration Plot

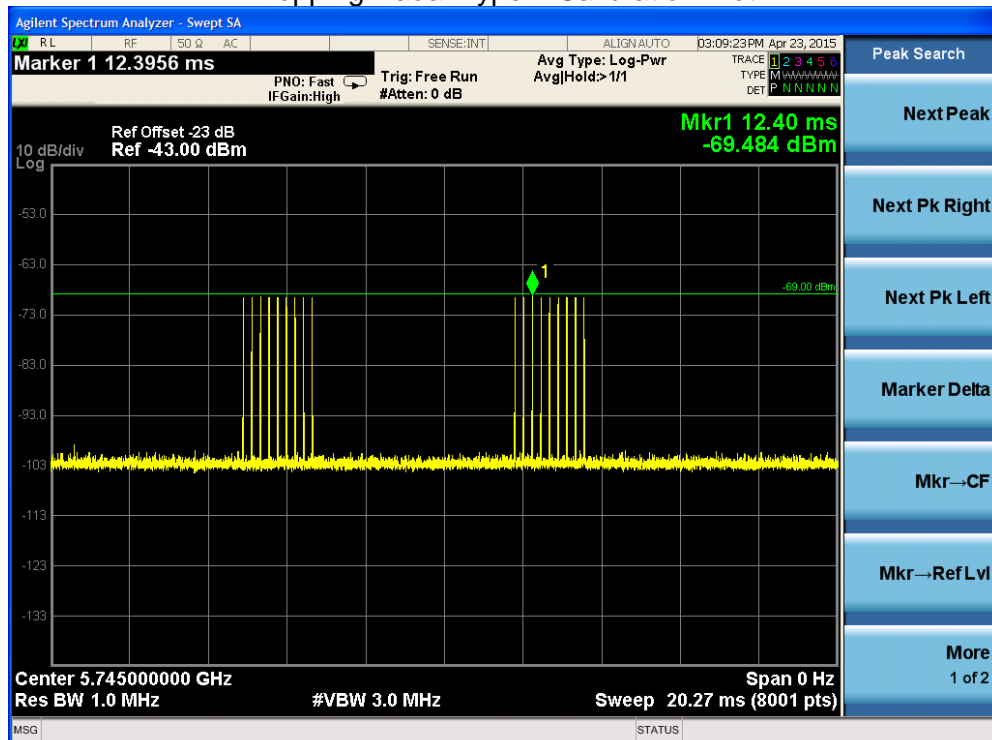

5.2. Initial Channel Availability Check Time Measurement

5.2.1 Test Limit

The Channel Availability Check shall be performed during a continuous period in time (Channel Availability Check Time) which shall not be less than the value defined in table 2-1.

5.2.2 Test Procedure

1. The devices will be powered on and be instructed to operate on the appropriate channel which falls within the frequency range 5725-5850MHz. At the same time the EUT is powered on, the spectrum analyzer will be set to zero span mode with a 1 MHz RBW and 3 MHz VBW on the Channel occupied by the radar (Ch_r). The spectrum analyzer's sweep will be started at the same time power is applied to the master device.
2. The EUT should not transmit any beacon or data transmissions until at least 1 minute after the completion of the power-on cycle.
3. Confirm that the EUT initiates transmission on the channel. Measurement system showing its nominal noise floor is marker1.

5.2.3 Test Result

The EUT does not transmit any beacon or data transmissions until at least 1 minute after the completion of the power-on cycle (89.30 sec). Initial beacons/data transmissions are indicated by marker 1 (29.30 sec).

Initial Channel Availability Check Time for 802.11n-HT20(5745MHz)

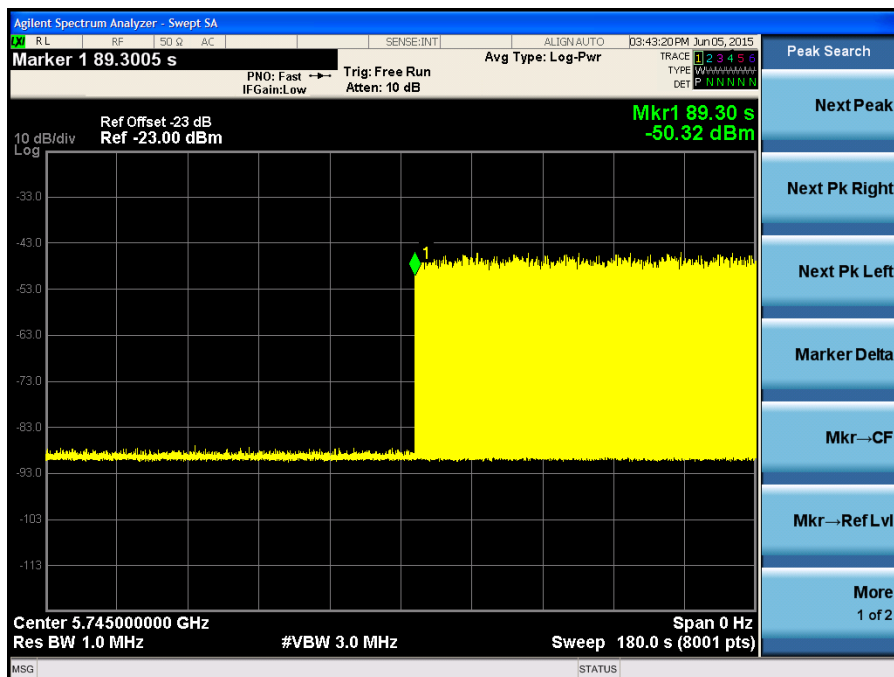

5.3. Radar Burst at the Beginning of the Channel Availability Check Time Measurement

5.3.1 Test Limit

The Channel Availability Check shall be performed during a continuous period in time (Channel Availability Check Time) which shall not be less than the value defined in table 2-1.

During the Channel Availability Check, the device shall be capable of detecting any of the radar signals that fall within the range given by tables 2-3 and 2-4 with a level above the Interference Detection Threshold defined in table 2-2.

The detection probability for a given radar signal shall be greater than the value defined in tables 2-3 and 2-4.

The Channel Revalidation Period for Available Channels remains valid for a maximum period as defined in table 2-1.

5.3.2 Test Procedure

a) The signal generator and UUT are connected using the test set-up described in clause 2.4 and the power of the UUT is switched off.

b) The UUT is powered on at T_0 . T_1 denotes the instant when the UUT has completed its power-up sequence ($T_{\text{power_up}}$) and is ready to start the radar detection. The Channel Availability Check is expected to commence on Ch_r at instant T_1 and is expected to end no sooner than $T_1 + T_{\text{ch_avail_check}}$ unless a radar is detected sooner.

Note: Additional verification may be needed to define T_1 in case it is not exactly known or indicated by the UUT.

c) A single radar burst is generated on Ch_r using the radar test signal #1 defined in table 2-3 at a level of up to 10 dB above the level defined in table 2-2. This single-burst radar test signal shall commence within 2 s after time T_1 .

d) It shall be recorded if the radar test signal was detected.

e) A timing trace or description of the observed timing and behaviour of the UUT shall be recorded.

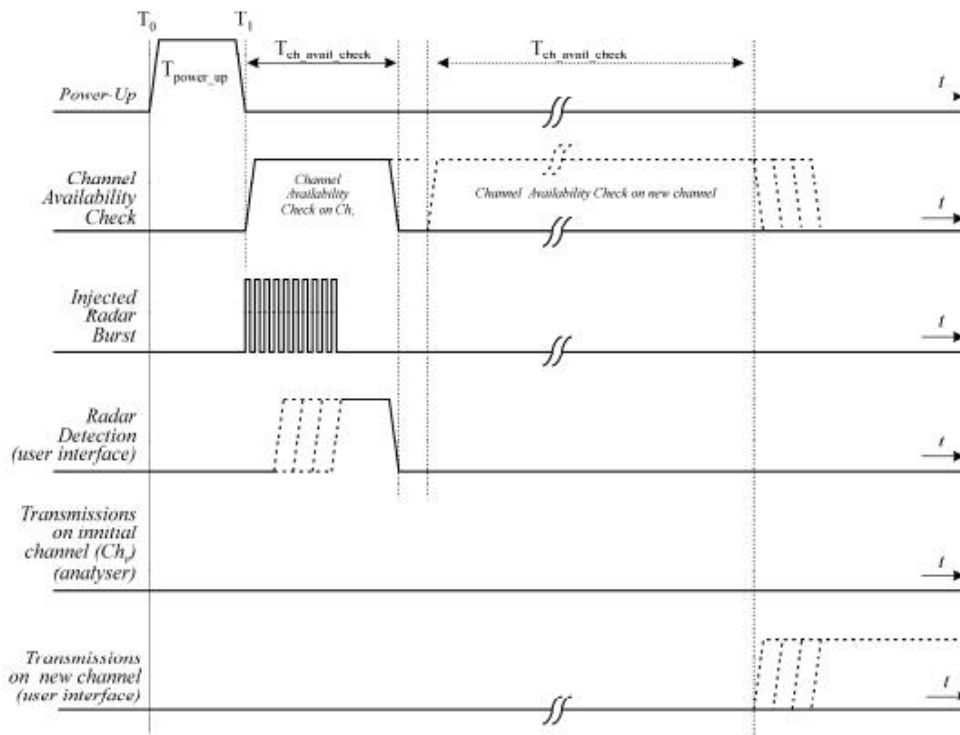

5.3.3 Test Result

Radar Burst at the Beginning of the Channel Availability Check Time for 802.11n-HT20 (5745MHz)

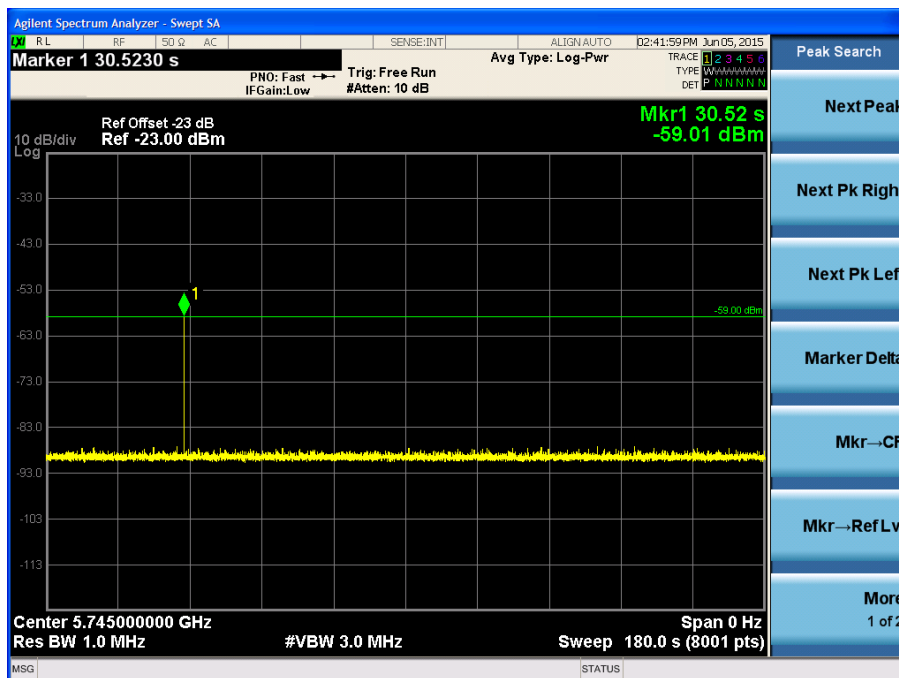

5.4. Radar Burst at the End of the Channel Availability Check Time Measurement

5.4.1 Test Limit

The Channel Availability Check shall be performed during a continuous period in time (Channel Availability Check Time) which shall not be less than the value defined in table 2-1.

During the Channel Availability Check, the device shall be capable of detecting any of the radar signals that fall within the range given by tables 2-3 and 2-4 with a level above the Interference Detection Threshold defined in table 2-2.

The detection probability for a given radar signal shall be greater than the value defined in tables 2-3 and 2-4.

The Channel Revalidation Period for Available Channels remains valid for a maximum period as defined in table 2-1.

5.4.2 Test Procedure

- a) The signal generator and UUT are connected using the test set-up described in clause 2.4 and the power of the UUT is switched off.
- b) The UUT is powered up at T_0 . T_1 denotes the instant when the UUT has completed its power-up sequence ($T_{\text{power_up}}$) and is ready to start the radar detection. The Channel Availability Check is expected to commence on Ch_r at instant T_1 and is expected to end no sooner than $T_1 + T_{\text{ch_avail_check}}$ unless a radar is detected sooner.
- c) A single radar burst is generated on Ch_r using the radar test signal #1 defined in table 2-3 at a level of up to 10 dB above the level defined in table 2-2. This single-burst radar test signal shall commence towards the end of the minimum required Channel Availability Check Time but not before time $T_1 + T_{\text{ch_avail_check}} - 2 \text{ s}$.
- d) It shall be recorded if the radar test signal was detected.
- e) A timing trace or description of the observed timing and behaviour of the UUT shall be recorded.

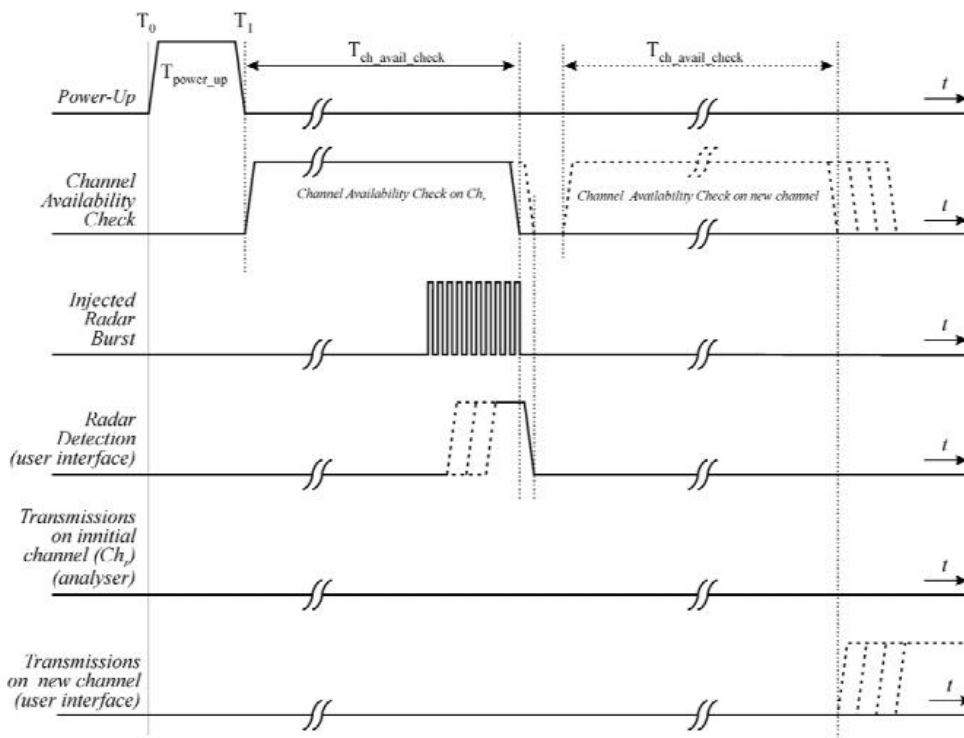

5.4.3 Test Result

Radar Burst at the End of the Channel Availability Check Time for 802.11n-HT20 (5745MHz)

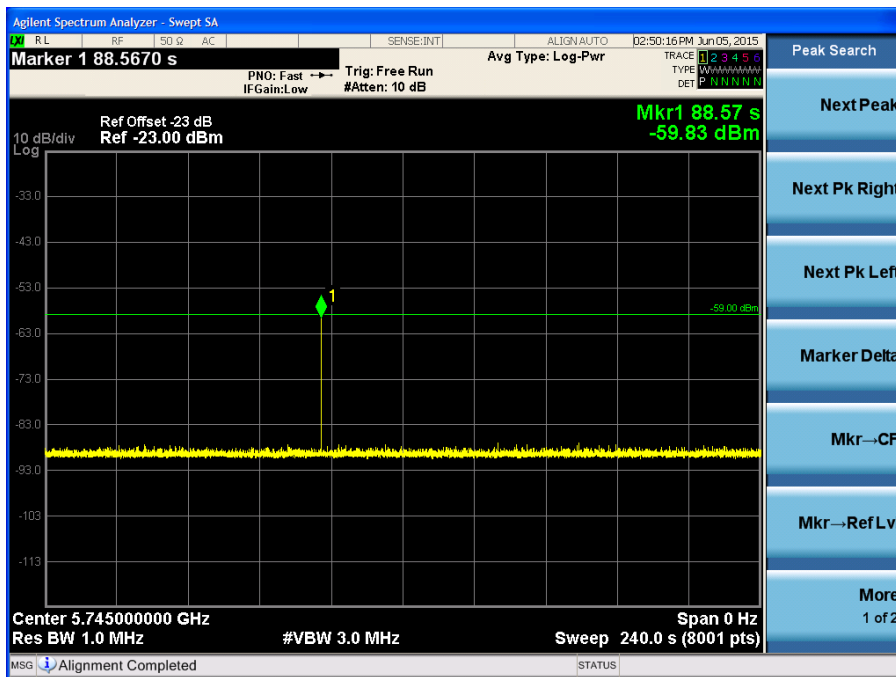

5.5. Interference Detection Threshold (during the Channel Availability Check)

5.5.1 Test Limit

The minimum required detection probability associated with a given radar test signal is defined in table 2-4.

5.5.2 Test Procedure

The different Steps below define the procedure to verify the Interference Detection Threshold during the Channel Availability Check Time This is illustrated in figure below.

- a) the signal generator and UUT are connected using the test set up described in clause 2.4 and the power of the UUT is switched off.
- b) The UUT is powered on at T_0 . T_1 denotes the instant when the UUT has completed its power-up sequence ($T_{\text{power_up}}$) and is ready to start the radar detection. The Channel Availability Check on Ch_r is expected to commence at instant T_1 and is expected to end no sooner than $T_1 + T_{\text{ch_avail_check}}$ unless a radar is detected sooner.
- c) a radar signal is generated on Ch_r using radar test signal #1 defined in table 2-3 at a level defined in table 2-2. This radar test signal shall commence at approximately 10 seconds after T_1 .
- d) It shall be recorded if the radar test signal was detected.
- e) the Steps c) to d) shall be repeated at least 20 times in the case of test signals simulating fixed frequency radars or 30 times in the case of test signals simulating frequency hopping radars in order to determine the detection probability for the selected radar test signal. The detection probability shall be compared with the limit specified in table 2-3 or 2-4 as appropriate.
- f) the Steps c) to e) shall be repeated for each of the radar test signals defined in table 2-3 and for each of the radar test signals defined in table D 3.2 where the single-burst radar signal is replaced by the multi-burst sequence defined in clause 5.3.6.1.1.

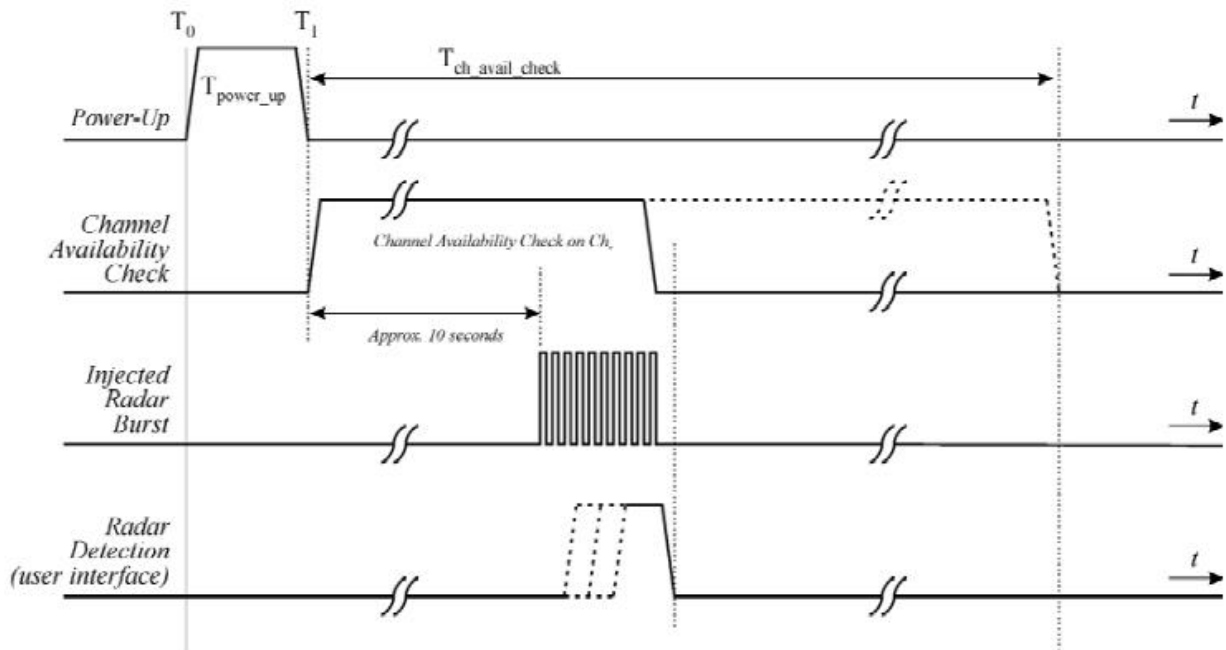

5.5.3 Test Result

802.11n-HT20 channel 149 5745MHz

Radar Wave Type	Detection Threshold	Trail Number	Detection Result	Limit	Note
Type 1	-69dBm	20	100%	60%	Pass
Type 2	-69dBm	20	100%	60%	Pass
Type 3	-69dBm	20	100%	60%	Pass
Type 4	-69dBm	20	100%	60%	Pass
Type 5	-69dBm	20	100%	60%	Pass
Type 6	-69dBm	20	100%	60%	Pass
Hopping Type 1	-69dBm	20	100%	60%	Pass
Hopping Type 2	-69dBm	20	100%	60%	Pass

5.6. In-Service Monitoring Measurement

5.6.1 Test Limit

The In-Service Monitoring shall be used to monitor each Operating Channel.

The In-Service-Monitoring shall start immediately after the RLAN has started transmissions on a channel.

During the In-Service Monitoring, the device shall be capable of detecting any of the radar signals that fall within the range given by tables 2-3 and 2-4 with a level above the Interference Detection Threshold defined in table 2-2.

The minimum required detection probability associated with a given radar test signal is defined in table 2-4.

5.6.2 Test Procedure Used

- a) The signal generator and UUT are connected using the test set-up described in clause 2.4.
- b) The UUT shall transmit a test transmission sequence on the selected channel Ch_r . While the testing is performed on Ch_r .
- c) At a certain time T_0 , a single burst radar test signal is generated on Ch_r using radar test signal #1 defined in 2-3 and at a level defined in table 2-2. T_1 denotes the end of the radar burst.
- d) It shall be recorded if the radar test signal was detected.
- e) the Steps c) to d) shall be repeated at least 20 times in the case of test signals simulating fixed frequency radars or 30 times in the case of test signals simulating frequency hopping radars in order to determine the detection probability for the selected radar test signal. The detection probability shall be compared with the limit specified in either table 2-3 or 2-4 as appropriate;
- f) the Steps b) to e) shall be repeated for each of the radar test signals defined in table 2-3 and for each of the radar test signals 1 and 2 in table D 3.2 where the single-burst radar signal is replaced by the multi-burst sequence defined in clause 5.3.6.1.1.

5.6.3 Test Result

802.11n-HT20 channel 149 5745MHz

Radar Wave Type	Detection Threshold	Trail Number	Detection Result	Limit	Note
Type 1	-69dBm	20	100%	60%	Pass
Type 2	-69dBm	20	100%	60%	Pass
Type 3	-69dBm	20	100%	60%	Pass
Type 4	-69dBm	20	100%	60%	Pass
Type 5	-69dBm	20	100%	60%	Pass
Type 6	-69dBm	20	100%	60%	Pass
Hopping Type 1	-69dBm	20	100%	60%	Pass
Hopping Type 2	-69dBm	20	100%	60%	Pass

5.7. Channel Shutdown and Non-Occupancy Period

5.7.1 Test Limit

Parameter	Value
Channel Move Time	< 10 s
Channel Closing Transmission Time	< 260 ms

5.7.2 Test Procedure Used

- The signal generator and UUT are connected using the test set-up described in clause 2.4.
- The UUT shall transmit a test transmission sequence on the selected channel Ch_r .
- At a certain time T_0 , a single burst test signal is generated on Ch_r using radar test signal #1 defined in table 2-3 and at a level of up to 10 dB above the level defined in table 2-2 on the selected channel. T_1 denotes the end of the radar burst.
- The transmissions of the UUT following instant T_1 on the selected channel Ch_r shall be observed for a period greater than or equal to the Channel Move Time defined in table 2-1. The aggregate duration (Channel Closing Transmission Time) of all transmissions from the UUT on Ch_r during the Channel Move Time shall be compared to the limit defined in 2-1.
- T_2 denotes the instant when the UUT has ceased all transmissions on the channel Ch_r . The time difference between T_1 and T_2 shall be measured. This value (Channel Move Time) shall be noted and compared with the limit defined in table 2-1.
- Following instant T_2 , the selected channel Ch_r shall be observed for a period equal to the Non-Occupancy Period ($T_3 - T_2$) to verify that the UUT does not resume any transmissions on this channel.

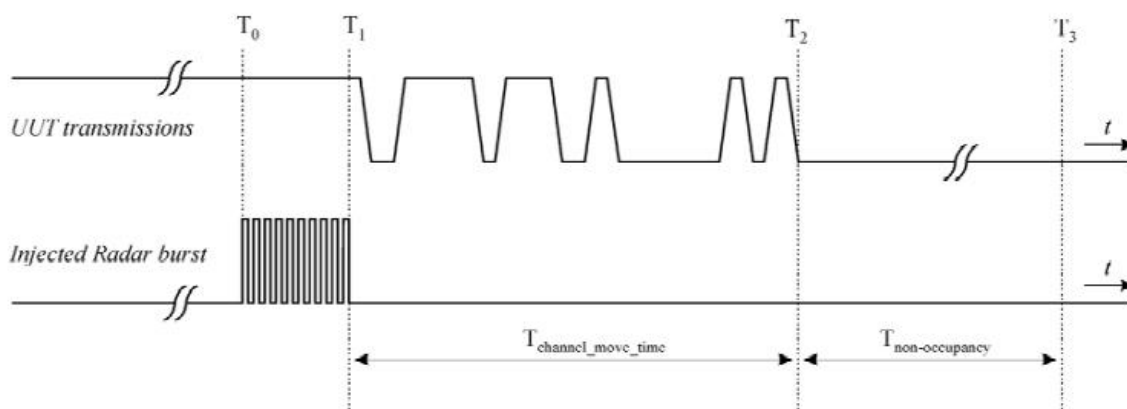

5.7.3 Test Result

Channel Closing Transmission Time and Channel Move Time

802.11n-HT20 channel 149 5745MHz

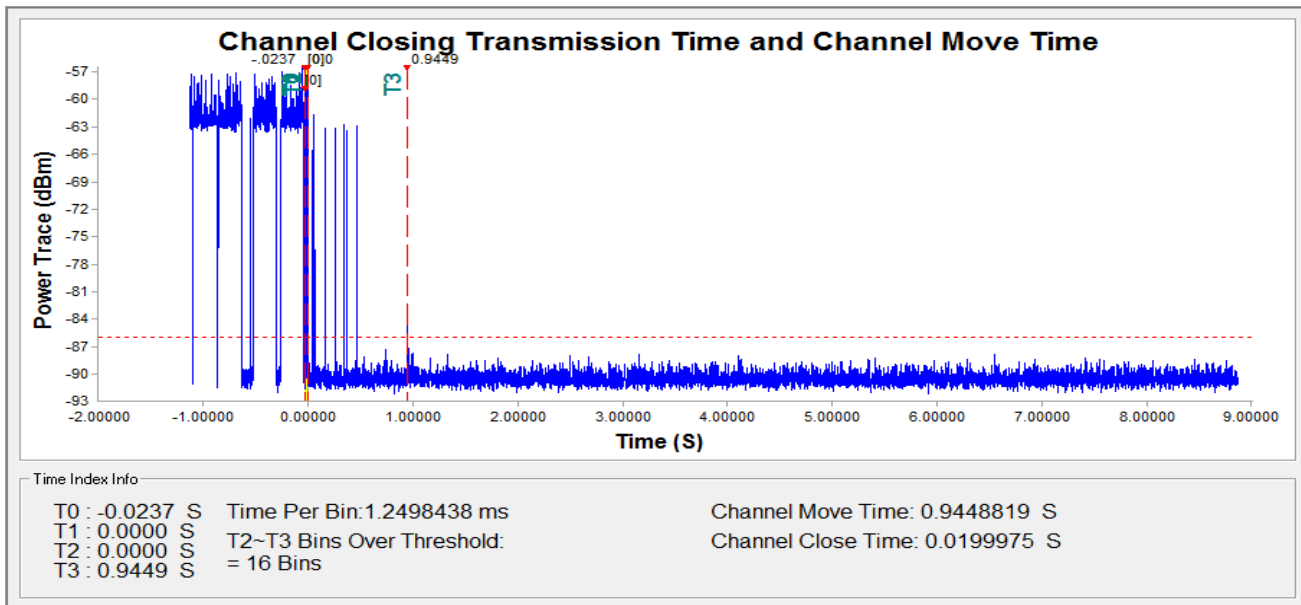
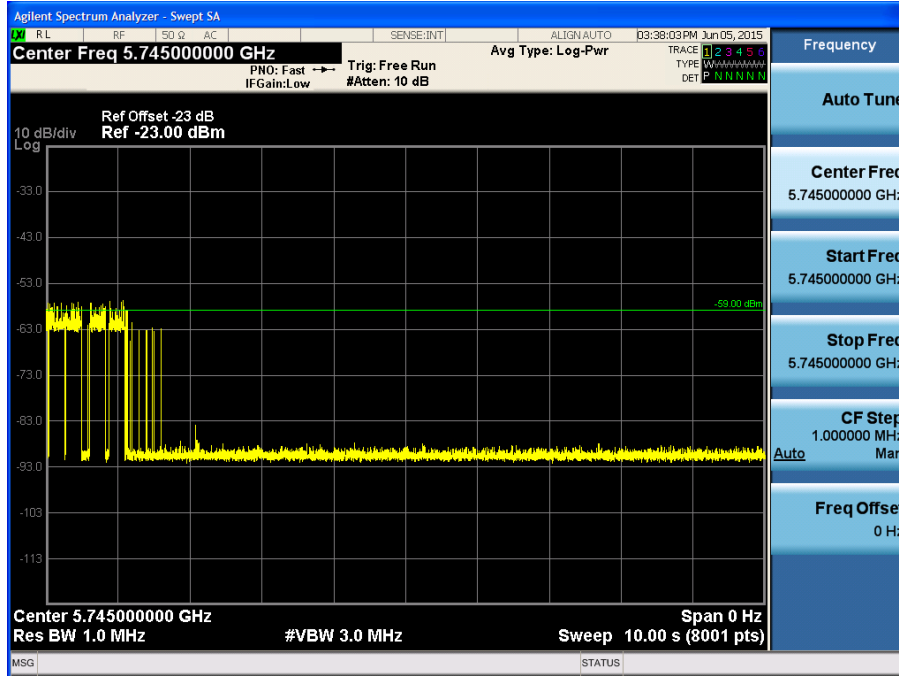

Test Item	Measured Time (s)	Limit	Results
Channel Move Time	0.945	< 10 s	Pass
Channel Closing Transmission Time	0.020	< 0.26 s	Pass

Non-Occupancy Period

802.11n-HT20 channel 149 5745MHz

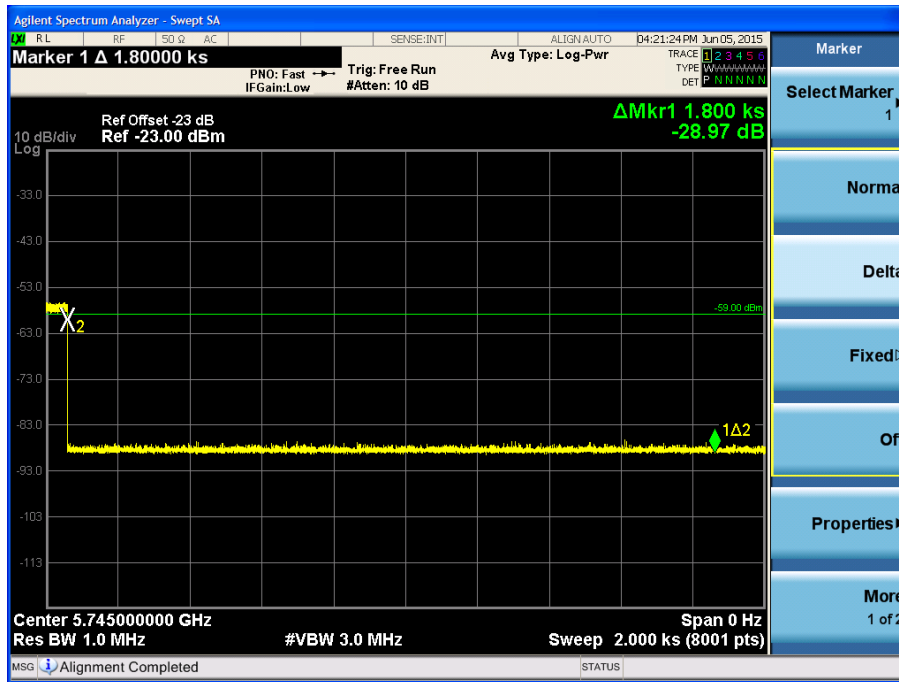

Test Item	Measured Time (ks)	Limit	Results
Non-Occupancy Period	> 30 Min	> 30 Min	Pass

The End